

AVX, the world's leading manufacturer of Tantalum capacitors, has now released the world first Niobium Oxide Capacitors. AVX Niobium Oxide Capacitors are drawing worldwide attention because of their non-burn technology and availability and stability of raw materials supply. AVX is committed to total customer satisfaction by delivering products of the highest quality, providing strong technical support, and at competitive prices. With one of the fullest lineups in the capacitor business, AVX can satisfy a broad range of customer needs in a myriad of applications.

Tantalum Series Guide

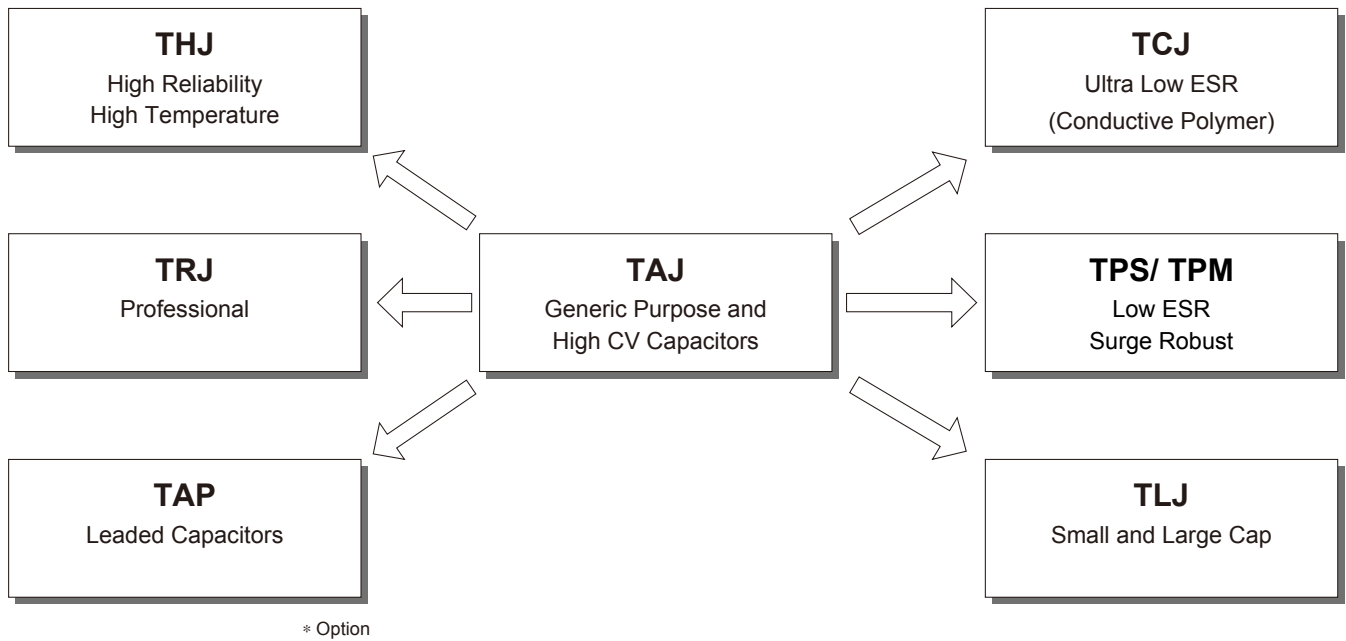

Niobium Oxide Series Guide

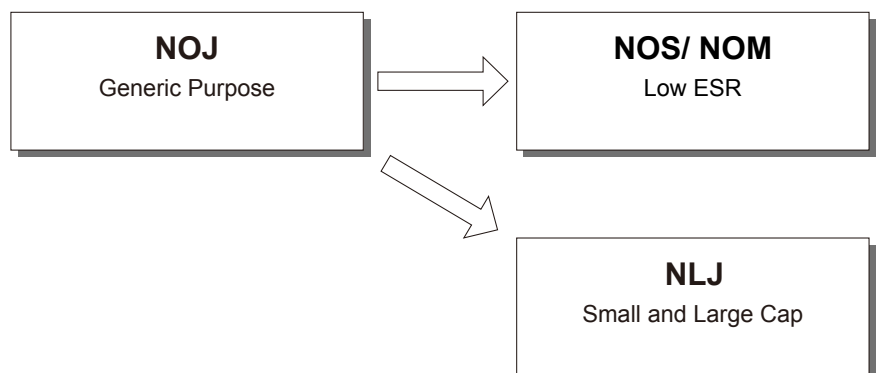

OxiCap™ NOJ (Standard) and NOS/ NOM (Low ESR) Series Niobium Oxide Capacitors

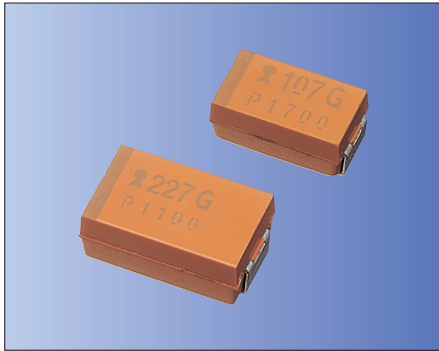

RoHS Compliant

Features

- Niobium oxide anode
- EIA case sizes same as tantalum capacitors
- High reliability
- Reduced burning at overloading
- Low ESR (NOS series)

Applications

- Electronic Equipment in General

How to Order

NOJ C 107 M 006 R WJV

① ② ③ ④ ⑤ ⑥ ⑧

NOS C 107 M 004 R 0150 V

① ② ③ ④ ⑤ ⑥ ⑦ ⑧

NOM E 477 M 004 R 0023 V

① ② ③ ④ ⑤ ⑥ ⑦ ⑧

- ① Series
- ② Case Size (See Table)
- ③ Capacitance (pF)
(Code: 2 Significant Digits and Number of Zeros)
- ④ Tolerance

M	±20%
----------	------

- ⑤ Rated DC Voltage

ex.	002	2.5VDC
004	4VDC	006 6.3VDC

- ⑥ Packaging

R	Plastic Tape (7" Reel)
----------	------------------------

- ⑦ ESR

ex.	0100	100mΩ
------------	-------------	-------

- ⑧ Special Requirements

(WJ) V	Dry Pack Option
---------------	-----------------

* D, E, X, Y and V case sizes are dry pack as standard specifications

Case Dimensions

(Unit: mm)

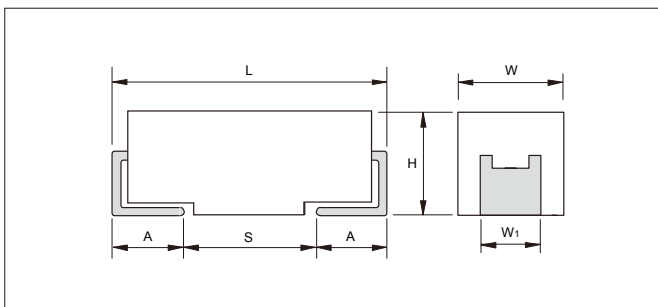

Case size	L	W	H	W ₁	A	S min.
A	3.2±0.2	1.6 ^{+0.2} _{-0.1}	1.6 ^{+0.2} _{-0.1}	1.2±0.2	0.8 ^{+0.3} _{-0.2}	1.1
B	3.5±0.2	2.8 ^{+0.2} _{-0.1}	1.9 ^{+0.2} _{-0.1}	2.2±0.2	0.8 ^{+0.3} _{-0.2}	1.4
C	6.0±0.2	3.2 ^{+0.2} _{-0.1}	2.6 ^{+0.2} _{-0.1}	2.2±0.2	1.3 ^{+0.3} _{-0.2}	2.9
D	7.3±0.2	4.3 ^{+0.2} _{-0.1}	2.9 ^{+0.2} _{-0.1}	2.4±0.2	1.3 ^{+0.3} _{-0.2}	4.4
E	7.3±0.2	4.3 ^{+0.2} _{-0.1}	4.1 ^{+0.2} _{-0.1}	2.4±0.2	1.3 ^{+0.3} _{-0.2}	4.4
V	7.3±0.2	6.1 ^{+0.2} _{-0.1}	3.45±0.3	3.1±0.2	1.4 ^{+0.3} _{-0.2}	4.4
F	6.0±0.2	3.2 ^{+0.2} _{-0.1}	2.0 max.	2.2±0.2	1.3 ^{+0.3} _{-0.2}	2.9
P	2.05±0.2	1.35 ^{+0.2} _{-0.1}	1.5 max.	1.0±0.2	0.5 ^{+0.3} _{-0.2}	0.85
S	3.2±0.2	1.6 ^{+0.2} _{-0.1}	1.2 max.	1.2±0.2	0.8 ^{+0.3} _{-0.2}	1.1
T	3.5±0.2	2.8 ^{+0.2} _{-0.1}	1.2 max.	2.2±0.2	0.8 ^{+0.3} _{-0.2}	1.4
W	6.0±0.2	3.2 ^{+0.2} _{-0.1}	1.5 max.	2.2±0.2	1.3 ^{+0.3} _{-0.2}	2.9
X	7.3±0.2	4.3 ^{+0.2} _{-0.1}	1.5 max.	2.4±0.2	1.3 ^{+0.3} _{-0.2}	4.4
Y	7.3±0.2	4.3 ^{+0.2} _{-0.1}	2.0 max.	2.4±0.2	1.3 ^{+0.3} _{-0.2}	4.4

Specifications <NOJ Series>

Rated Voltage (V _R) ≤+ 85°C	1.8	2.5	4	6.3	10	
Category Voltage (V _C) ≤+105°C	1.2	1.7	2.7	4	7	
Surge Voltage (V _S)	≤+ 85°C	2.3	3.3	5.2	8	13
	≤+105°C	1.6	2.2	3.4	5	8
Operating Temperature Range	-55°C to +105°C					
Failure Rate	0.5%/ 1000H (85°C, Rated Voltage, 0.1Ω/ V)					

Specifications <NOS/ NOM Series>

Rated Voltage (V _R) ≤+ 85°C	1.8	2.5	4	6.3	
Category Voltage (V _C) ≤+125°C	0.9	1.3	2	3	
Surge Voltage (V _S)	≤+ 85°C	2.3	3.3	5.2	8
	≤+125°C	1.2	1.7	2.6	4
Operating Temperature Range	-55°C to +125°C				
Failure Rate	0.2%/ 1000H (85°C, Rated Voltage, 0.1Ω/ V)				

Ignition Energy and Burning Rate

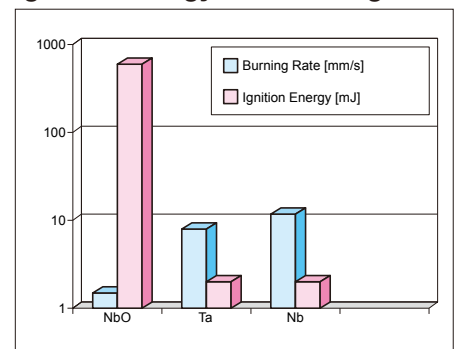

Specific Heat

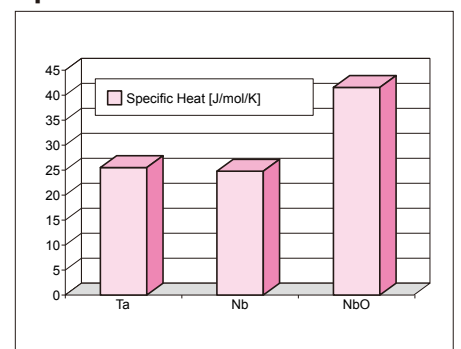

Low Voltage Derating

DC/ DC power input rating recommendation*		
Rated Voltage		
Rail Voltage	OxiCap	Tantalum
3.5V	4V	6.3V
5V	6.3V	10V
8V	10V**	16V

* at room temperature 25°C

** 10V is available for NOJ only

Capacitance and Voltage Range <NOJ Series>

Capacitance		Capacitance Range (letter denotes case code)				
		Rated Voltage				
μF	CODE	1.8V	2.5V	4V	6.3V	10V
2.2	225					B
4.7	475				A	A
6.8	685				A	A
10	106				A	A/ B
15	156			A	A/ B	A/ B
22	226		A	A/ B	A/ B	B/ C
33	336		A/ B	A/ B	B/ C	C
47	476	A/ B	A/ B	A/ B/ C	B/ C	C
68	686	B	B/ C	B/ C	B/ C	C
100	107	B/ C	B/ C	B/ C	B/ C/ D	D
150	157	C	C	C/ D	C/ D	
220	227	C	C	C/ D	C/ D/ E	
330	337	C	C/ D	D	D/ E	
470	477		D/ E	D/ E	E/ V	
680	687		E	E/ V		
1000	108		V	V		

Note: Voltage ratings are minimum values. AVX reserves the right to supply higher voltage ratings in the same case size, to the same reliability standards.

Capacitance and Voltage Range <NOJ Series (Low Profile) >

Capacitance		Capacitance Range (letter denotes case code)				
		Rated Voltage				
μF	CODE	1.8V	2.5V	4V	6.3V	10V
2.2	225					P
3.3	335					P
4.7	475				P/ S	T
6.8	685			P/ S	P/ S/ T	T
10	106		P/ S	P/ S/ T	P/ T	T
15	156	P/ S	P/ S/ T	P/ T		
22	226	P/ S/ T	P/ T	T	T	
33	336	T	T	T	W	
47	476	T	T	W	W	
68	686		W	W	X/ Y	
100	107	W	W	W/ X	F/ Y	
150	157		X	Y	F/ Y	
220	227	X	Y	F/ Y	Y	
330	337	Y	Y	Y		
470	477	Y				

Note: Voltage ratings are minimum values. AVX reserves the right to supply higher voltage ratings in the same case size, to the same reliability standards.

Capacitance and Voltage Range <NOS/ NOM Series>

Capacitance		Capacitance Range (letter denotes case code)			
		Rated Voltage			
μF	CODE	1.8V	2.5V	4V	6.3V
10	106				A (800, 1000, 2000)
15	156			A (1500)	B (600)
22	226		A (900)	B (600)	B (600)
33	336			B (600)	B (600) C (500) W (250)
47	476		B (500)	B (500) C (300) W (150)	B (500)/ C (300)
68	686		C (200) W (150)	C (200)	C (75, 200) X (100) Y (100)
100	107	B (350) W (150)	C (150)	C (70, 150) X (100)	C (150) D (80, 100) Y (100)
150	157		C (65, 150) X (100)	C (90, 150) Y (100)	D (50, 70, 100) Y (100)
220	227	C (125) X (100)	C (80, 125) Y (100)	D (40, 60, 100) Y (100)	D (45, 60, 100)/ E (80, 100) E (40)
330	337	Y (100)	D (35, 50, 100) Y (100)	D (35, 55, 100)/ E (100)/ Y (150) E (35)	E (80, 100) E (23, 35)
470	477	Y (100)	D (35, 55, 100)/ E (100) E (30)	D (100)/ E (75, 100) E (23, 30)	V (75)
680	687	E (23)	E (60) E (23)	V (75)	
1000	108		V (50)		

Note: Voltage ratings are minimum values. AVX reserves the right to supply higher voltage ratings in the same case size, to the same reliability standards.
 Shaded portion indicates NOM series products.

Packaging

Tape and reel packaging for automatic component placement.
Please enter required suffix code, R or S on order.

• Reel

(Unit: mm)

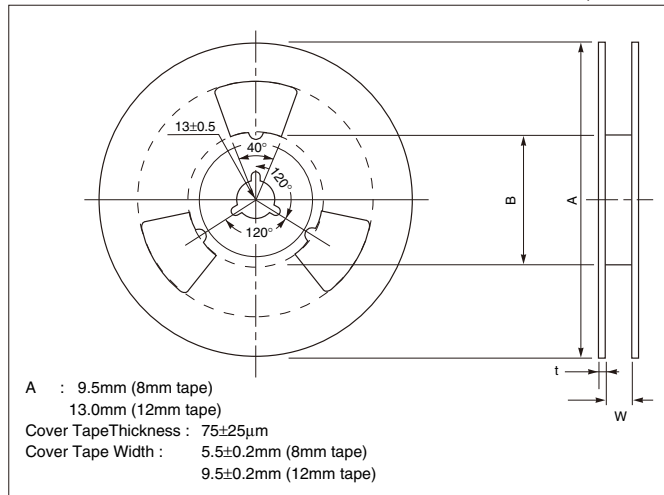

Reel Size	Tape width (mm)	A	B	C	W	t
180mm (7")	12	180±2.00	50 min.	13.0±0.50	12.4+1.5/-0	2.0±0.50
180mm (7")	8	180±2.00	50 min.	13.0±0.50	8.4+1.5/-0	2.0±0.50

• Taping

Series	Case Size	Tape Width (mm)	P (mm)	7" Reel (pcs.)
TAJ TPS TPM TCJ TLJ TRJ THJ NOJ NOS NOM NLJ	A	8	4	2000
	B	8	4	2000
	C	12	8	500
	D	12	8	500
	E	12	8	400
	F	12	8	1000
	G	8	4	2500
	H	8	4	2500
	J	8	4	4000
	K	8	4	3000
	N	8	4	3000
	P	8	4	2500
	R	8	4	2500
	S	8	4	2500
	T	8	4	2500
	V	12	8	400
	W	12	8	1000
	X	12	8	1000
Y	12	8	1000	

• Carrier Tape

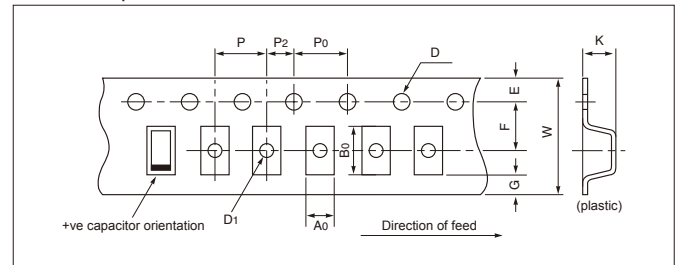

Tape dimensions comply to EIA 481 A.
Dimensions A₀ and B₀ of the pocket and the tape thickness, K, are dependent on the components size.
Tape material do not affect component solderability during storage.
Carrier tape thickness < 0.4mm

(Unit: mm)

Code	8mm tape	12mm tape
P	4±0.1	8±0.1
G	0.75 min.	0.75 min.
F	3.5±0.05	5.5±0.05
E	1.75±0.1	1.75±0.1
W	8±0.3	12±0.3
P ₂	2±0.05	2±0.05
P ₀	4±0.1	4±0.1
D	1.5 ^{+0.2} _{-0.0}	1.5 ^{+0.2} _{-0.0}
D ₁	1.0 min.	1.5 min.

• Carrier Tape

(Unit: mm)

Series	Case Size	A ₀	B ₀	K
TAJ TPS TPM TCJ TLJ TRJ THJ NOJ NOS NOM NLJ	A	1.83±0.1	3.57±0.1	1.87±0.1
	B	3.15±0.1	3.77±0.1	2.22±0.1
	C	3.45±0.1	6.4±0.1	2.92±0.1
	D	4.48±0.1	7.62±0.1	3.22±0.1
	E	4.5±0.1	7.5±0.1	4.5±0.1
	F	3.35±0.1	6.4±0.1	2.2±0.1
	G	1.83±0.1	3.57±0.1	1.65±0.1
	H	3.15±0.1	3.77±0.1	1.66±0.1
	J	1.0±0.05	1.8±0.05	1.0±0.05
	K	1.95±0.1	3.55±0.1	1.15±0.1
	N	1.60±0.1	2.30±0.1	1.10±0.1
	P	1.65±0.1	2.45±0.1	1.6±0.1
	R	1.65±0.1	2.45±0.1	1.3±0.1
	S	1.95±0.1	3.55±0.1	1.3±0.1
	T	3.2±0.1	3.8±0.1	1.3±0.1
	V	6.43±0.1	7.44±0.1	3.84±0.1
	W	3.57±0.1	6.4±0.1	1.65±0.1
	X	4.67±0.1	7.62±0.1	1.65±0.1
Y	4.67±0.1	7.62±0.1	2.15±0.1	

Recommended Land Pattern

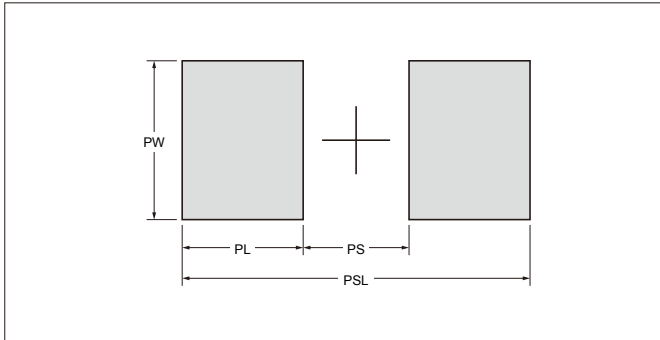

(Unit: mm)

Series	Case Size	PSL	PL	PS	PW
TAJ TPS TPM TCJ TLJ TRJ THJ NOJ NOS NOM NLJ	A	4.00	1.40	1.20	1.80
	B	4.00	1.40	1.20	2.80
	C	6.50	2.00	2.50	2.80
	D	8.00	2.00	4.00	3.00
	E	8.00	2.00	4.00	3.00
	F	6.50	2.00	2.50	2.80
	G	4.00	1.40	1.20	1.80
	H	4.00	1.40	1.20	2.80
	J	2.80	1.10	0.60	1.00
	K	4.00	1.40	1.20	1.80
	N	2.70	0.95	0.80	1.60
	P	2.70	0.95	0.80	1.60
	R	2.70	0.95	0.80	1.60
	S	4.00	1.40	1.20	1.80
	T	4.00	1.40	1.20	2.80
	V	8.00	2.00	4.00	3.70
W	6.50	2.00	2.50	2.80	
X	8.00	2.00	4.00	3.00	
Y	8.00	2.00	4.00	3.00	

Recommended Reflow Profile for Lead-Free Product

Allowable range of peak temp./ time combination for IR reflow

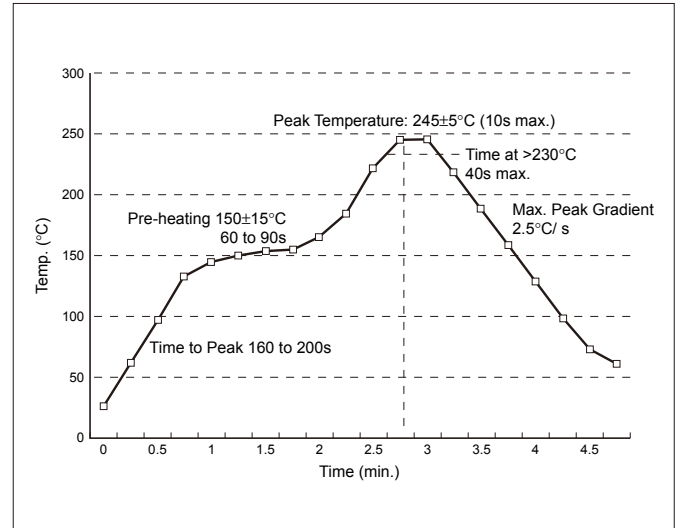

Please contact us for Lead-Free Products.

Manual Soldering Using Soldering Iron

Item	Condition
Max. Tip Temperature	370°C max.
Max. Exposure Time	3 sec. max.

Technical Summary

1. Voltage Derating

We can offer to use AVX software "Select-a-Cap" to select a part number for safety use.

2. Surge Current

As a general rule of thumb, the maximum current a tantalum capacitor can withstand is given by the following equation.

$$I_{max} = V_{rated} / (0.65 + \text{Catalog ESR})$$

So for example for D case/ 100uF/ 10V capacitor (Catalog ESR = 0.9 Ohms)

This would be :

$$I_{max} = 10 / (0.65 + 0.9) \doteq 6.45\text{Amps}$$

3. If more aggressive mounting techniques are to be used, please contact AVX Tantalum for guidance.

4. Reverse Voltage

The values quoted are not intended to cover continuous reverse operation.

The peak reverse voltage applied to the capacitor must not exceed.

- 10% of rated DC voltage to a maximum of 1V at 25°C.
- 3% of rated DC voltage to a maximum of 0.5V at 85°C.
- 1% of category DC voltage to a maximum of 0.1V at 125°C.